



QZV **QZV**
DIN EN ISO DIN EN ISO
14001 **9001**
zertifiziert zertifiziert



Lubrication couplings and tubing



Fritsche GmbH & Co. KG
Eichenhöhe 4-5
21255 Kakenstorf Germany

Phone +49 (0) 41 86 - 88 82 90
Fax +49 (0) 41 86 - 88 82 999
www.centrollubrication.com

Version 2011-12

Preamble

Dear customers,

we're a worldwide operating company
specialized in

**fittings and hose cables
type LL for lubrication technologies**

On the following pages you can get an overview about our product range.
Of course we deliver apart from our standard-range more fittings and
hose cables in other sizes and materials.

We produce from samples or graph as well

Kind Regards
Your Fritsche Team



Index

Page	Page
2 Preamble	35 Coupling socket with return flow port
3 Index	Coupling plug
4 Elbow screw fitting	36 Stub for coupling plug
5 Elbow connectors screw type / body	Dust cover for stub
6 Straight screwel coupling	37 Greasing block T-drilled thread M10x1
7 Straight connector type / body	Closure plug
8 Connector	38 T-banjo fitting
Equal tee	High pressure gresse nipple
9 Nonreturn valve	39 Manometer
10 Coupling nut	Adjustable screw connection for manometer
Cutting ring	40 Mounting clips
11 Bulkhead M10x1	41 Purchase order
12 Bulkhead straight / elbow	
13 Banjo fitting freely movable, 90° angle	
Swivel union	
14 Straight connector push-in type	
Connector push-in type	
15 Elbow-connector push-in type	
16 Swivel freely movable push-in type 90°	
17 Adapter 45 °	
Adapter 90°	
18 Adapter, extension piece	
19 Socket union for double cone olive	
Double cone olive	
20 Plastic tube semi-rigid	
Plastic tube flexibel	
21 High pressure hose / 840 Bar	
22 Hose stud straight	
Hose stud with claw groove	
23 Hose stud 90°	
Hose stud with claw groove 90°	
24 Hose stud 45°	
Hose stud with claw groove 45°	
25 Screw sleeve	
26 Protective hose	
Plastic helix	
27 Elbows with tapered thread	
28 Socket unions for tapered sleeves	
Tapered sleeves	
29 Reinforcing socket for plastictube	
30 Hose strap	
Illuminated push button	
31 Filling pump	
Filling connection	
32 Filling connection straight / 90°	
33 Cuppling female / cuppling male / adapter	
34 Coupling female / coupling male screw	

Elbow screw fitting DIN 2353 / ISO 8434-1

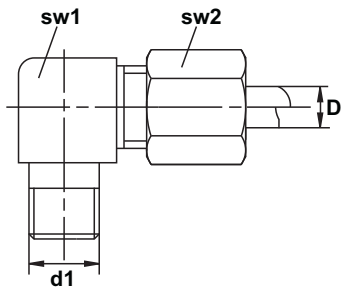

c.-item no	item no.	D	d1	sw1	sw2
	104 - 101	4	M 6 x 1 tap	9	10
	104 - 102	4	M 8 x 1 tap	9	10
	104 - 103	4	M 10 x 1 tap	9	10
	104 - 104	4	R 1/8 BSP tap	9	10
	106 - 101	6	M 6 x 1 tap	11	12
	106 - 101 - VA*	6	M 6 x 1 tap	11	12
	106 - 102	6	M 8 x 1 tap	11	12
	106 - 102 - VA*	6	M 8 x 1 tap	11	12
	106 - 103	6	M 10 x 1 tap	11	12
	106 - 103 - VA*	6	M 10 x 1 tap	11	12
	106 - 104	6	R 1/8 BSP tap	11	12
	106 - 104 - VA*	6	R 1/8 BSP tap	11	12
	106 - 105 - L	6	R 1/4 BSP tap	12	14

Material: steel, galvanized surface

* Material: stainless steel 1.4571/316ti

Elbow connectors screw type / body

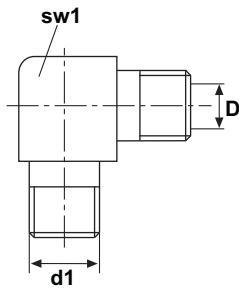

c.-item no	item no.	D	d1	sw1
	104 - 131	4	M 6 x 1 tap	9
	104 - 132	4	M 8 x 1 tap	9
	104 - 133	4	M 10 x 1 tap	11
	104 - 134	4	R 1/8 BSP tap	11
	106 - 131	6	M 6 x 1 tap	11
	106 - 132	6	M 8 x 1 tap	11
	106 - 133	6	M 10 x 1 tap	11
	106 - 134	6	R 1/8 BSP tap	11

Material: steel, galvanized surface

Straight screwel coupling

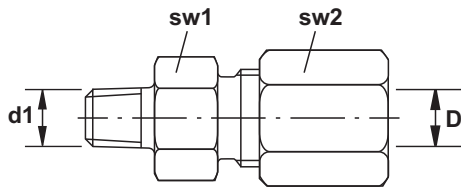

c.-item no	item no.	D	d1	sw1	sw2
	104 - 001	4	M 6 x 1 tap	11	10
	104 - 002	4	M 8 x 1 tap	11	10
	104 - 003	4	M 10 x 1 tap	11	10
	104 - 004	4	R 1/8 BSP tap	11	10
	106 - 001	6	M 6 x 1 tap	11	12
	106 - 001 - VA*	6	M 6 x 1 tap	11	12
	106 - 002	6	M 8 x 1 tap	11	12
	106 - 002 - VA*	6	M 8 x 1 tap	11	12
	106 - 003	6	M 10 x 1 tap	11	12
	106 - 003 - VA *	6	M 10 x 1 tap	11	12
	106 - 004	6	R 1/8 BSP tap	11	12
	106 - 004 - VA*	6	R 1/8 BSP tap	11	12
	106 - 005 - L	6	R 1/4 BSP tap	12	14
	108 - 001	8	M 6 x 1 tap	14	14
	108 - 002	8	M 8 x 1 tap	14	14
	108 - 003	8	M 10 x 1 tap	14	14
	108 - 004	8	R 1/8 BSP tap	14	14

Material: steel, galvanized surface

* Material: stainless steel 1.4571/316ti

Straight connector type / body

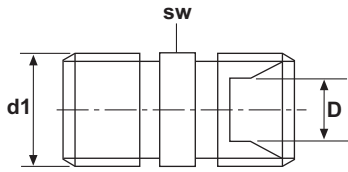

c.-item no	item no.	d1	D	sw
	104 - 031	M 6 x 1 tap	4	9
	104 - 032	M 8 x 1 tap	4	9
	104 - 033	M 10 x 1 tap	4	11
	104 - 034	R 1/8 BSP tap	4	11
	106 - 031	M 6 x 1 tap	6	11
	106 - 032	M 8 x 1 tap	6	11
	106 - 033	M 10 x 1 tap	6	11
	106 - 034	R 1/8 BSP tap	6	11

Material: steel, galvanized surface

Connector

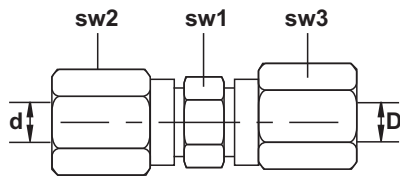

c.-item no	item no.	d	D	sw1	sw2	sw3
	104 - 000	4	4	9	10	10
	104 - 000 - VA *	4	4	9	10	10
	104 - 000 - 6	4	6	11	10	12
	106 - 000	6	6	11	12	12
	106 - 000 - VA *	6	6	11	12	12
	106 - 000 - 8	6	8	12	12	14
	106 - 000 - 10 - L	6	10	17	14	19
	108 - 000	8	8	12	14	14
	108 - 000 - L	8	8	14	17	17
	108 - 000 - VA - L *	8	8	14	17	17
	110 - 000 - L	10	10	17	19	19
	110 - 000 - VA - L *	10	10	17	19	19

Material: steel, galvanized surface

* Material: stainless steel 1.4571/316ti

Equal tee

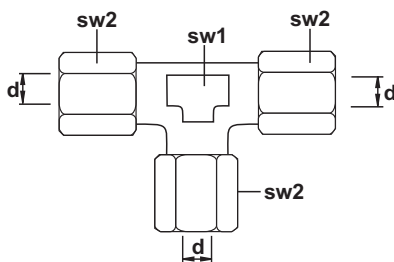

c.-item no	item no.	d	sw1	sw2
	104 - 300	4	9	10
	106 - 300	6	11	12
	106 - 300 - L	6	12	14
	108 - 300	8	12	14

Material: steel, galvanized surface

Nonreturn valve / body



Abb. 1



Abb. 2

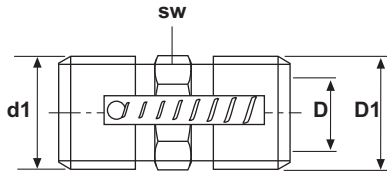

Abb. 3

c.-item no	item no.	d1	D	D1	sw
	106 - 033 - RVB Abb. 1	M 10 x 1	6	M 10 x 1	11
	106 - 033 - RV L * Abb. 2	M 10 x 1	6	M 10 x 1	11
	106 - 033 - RVV Abb. 3	M 10 x 1 tap	6	M 10 x 1	11
	106 - 033 - RVV - VA ** Abb. 3	M 10 x 1 tap	6	M 10 x 1	11

Material: steel, galvanized surface

* black

** Material: stainless steel 1.4571/316ti

Nonreturn valve complete with coupling nut and cutting ring



Abb. 1



Abb. 2

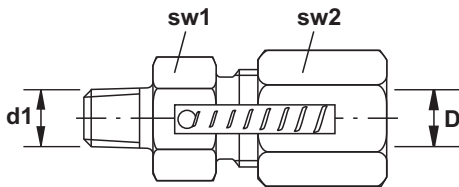

Abb. 3

c.-item no	item no.	d1	D	sw1	sw2
	106 - 003 - RVB Abb. 1	M 10 x 1	6	11	12
	106 - 003 - RV L * Abb. 2	M 10 x 1	6	11	12
	106 - 003 - RVV Abb. 3	M 10 x 1 tap	6	11	12
	106 - 003 - RVV - VA ** Abb. 3	M 10 x 1 tap	6	11	12

Material: steel, galvanized surface

* black

** Material: stainless steel 1.4571/316ti

Coupling nut

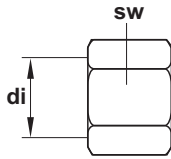

c.-item no	item no.	di	SW
	104 - 200	4	10
	106 - 200	6	12
	106 - 200 - VA*	6	12
	106 - 200 - SW black	6	12
	108 - 200	8	14
	110 - 200 - L	10	19

Material: steel, galvanized surface

* Material: stainless steel 1.4571 / 316ti

Cutting ring

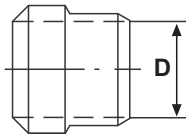

c.-item no	item no.	D
	104 - 210	4
	106 - 210	6
	106 - 210 - VA*	6
	108 - 210	8
	110 - 210 - L	10

Material: steel, galvanized surface

* Material: stainless steel 1.4571/316ti

Bulkhead

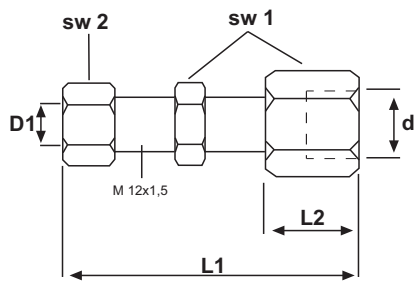

c.-item no	item no.	D1	d	L1	L2	SW1	SW2
	106 - 241 - L	6	M 6 x 1	33	5	17	14
	106 - 243 - L	6	M 10 x 1	66	20	17	14

Material: steel, galvanized surface

Bulkhead straight

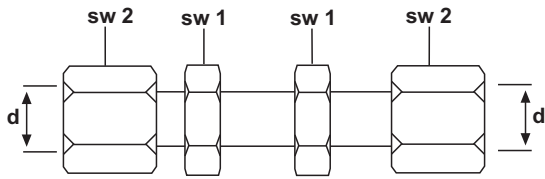

c.-item no	item no.	d	sw1	sw2
	106 - 221 - L	6	17	14
	106 - 221 - L - VA *	6	17	14
	108 - 221 - L	8	17	17

Material: steel, galvanized surface

*Material: stainless steel 1.4571/316ti

Bulkhead elbow

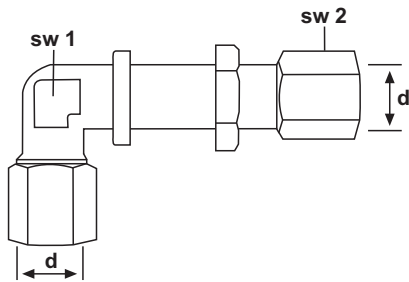

c.-item no	item no.	d	sw1	sw2
	106 - 231 - L	6	12	14
	106 - 231 - L - VA *	6	12	14
	108 - 231 - L	8	14	17

Material: steel, galvanized surface

*Material: stainless steel 1.4571/316ti

Banjo fitting freely movable, 90° angle

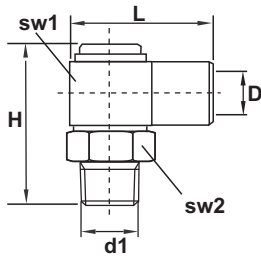

c.-item no	item no.	D	d1	sw1	sw2	H	L	tube Ø
	104 - 172	M 8 x 1	M 8 x 1 tap	15	14	30	26,5	4
	104 - 173	M 8 x 1	M 10 x 1 tap	15	14	30	26,5	4
	106 - 171*	M 10 x 1	M 6 x 1 tap	15	14	30	29	6
	106 - 172	M 10 x 1	M 8 x 1 tap	15	14	30	29	6
	106 - 173	M 10 x 1	M 10 x 1 tap	15	14	30	29	6
	106 - 174	M 10 x 1	R 1/8 BSP tap	15	14	30	29	6

Material: brass

*Material: brass, steel



Abb.1



Abb.2

It's also possible to connect a lubrication line directly to a swivel joint.

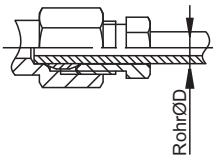
Swivel union

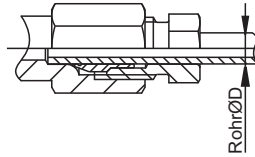
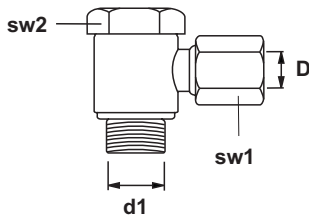

c.-item no	item no.	D	d1	sw1	sw2
	106 - 123	6	M 10 x 1	12	14
	106 - 124	6	R 1/8	12	14

Material: steel, galvanized surface

Push-in straight connector (for plastic tube)

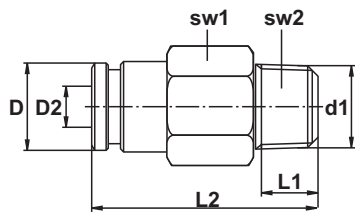

c.-item no	item no.	D	D1	D2	sw1	sw2	L1	L2
	104 - 051	9	M 6 x 1 tap	4	10	3	7,5	18,5
	104 - 052	9	M 8 x 1 tap	4	10	2,5	8	23
	104 - 053	9	M 10 x 1 tap	4	10	3	8	20
	104 - 054	9	R 1/8 BSP tap	4	11	3	8	20
	104 - 054 - NPT	9	1/8 NPT	4	11	3	8	20
	104 - 055 - UNF	9	1/4 - 28 UNF	4	11	3	8	20
	106 - 051	12	M 6 x 1 tap	6	12	3	7,5	21,5
	106 - 052	12	M 8 x 1 tap	6	12	2,5	8	25,5
	106 - 053	12	M 10 x 1 tap	6	12	4	8	25,5
	106 - 054	12	R 1/8 BSP tap	6	12	4	8	22
	106 - 054 - NPT	12	1/8 NPT	6	12	3	8,5	21,5
	106 - 055 - UNF	12	1/4 - 28 UNF	6	12	3	6	23,5

Material: plated brass

operating pressure 80 bar

Push-in connector (for plastic tube)

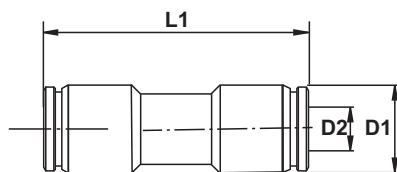

c.-item no	item no.	D1	D2	L1
	104 - 110	9	4	28
	106 - 110	12	6	31,5

Material: plated brass

operating pressure 60 bar

Push-in elbow-connector (for plastic tube)

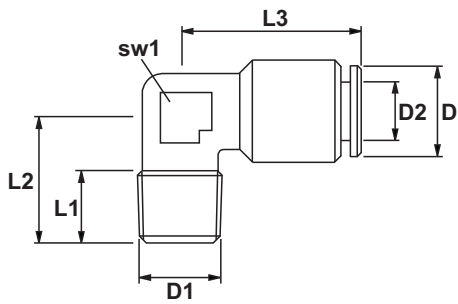

c.-item no	item no.	D	D1	D2	sw1	L1	L2	L3
	104 - 151	9	M 6 x 1 tap	4	10	7,5	16,5	20
	104 - 152	9	M 8 x 1 tap	4	10	8	16,5	20
	104 - 153	9	M 10 x 1 tap	4	10	8	17	20
	104 - 154	9	R 1/8 BSP tap	4	10	8	15	20
	104 - 154 - NPT	9	1/8 NPT	4	10	8	17	20
	104 - 155 - UNF	9	1/4 - 28 UNF	4	10	8	17	20
	106 - 151	12	M 6 x 1 tap	6	10	7,5	16,5	21
	106 - 152	12	M 8 x 1 tap	6	10	8	16,5	21
	106 - 153	12	M 10 x 1 tap	6	10	8	17	21
	106 - 154	12	R 1/8 BSP tap	6	10	8	15	21
	106 - 154 - NPT	12	1/8 NPT	6	10	8	16	21
	106 - 155 - UNF	12	1/4 - 28 UNF	6	10	7	15	21

Material: plated brass

operating pressure 60 bar

Push-in swivel freely movable connector 90° (for plastic tube)

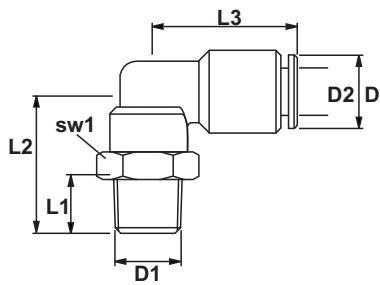

c.-item no	item no.	D	D1	D2	sw1	L1	L2	L3
	104 - 111	9	M 6 x 1 tap	4	13	8	20,5	20
	104 - 112	9	M 8 x 1 tap	4	13	8	20,5	20
	104 - 113	9	M 10 x 1 tap	4	13	8	21,5	20
	104 - 114	9	R 1/8 BSP tap	4	13	7,5	20	20
	104 - 114 - NPT	9	1/8 NPT	4	13	8,5	21,5	
	104 - 115 - UNF	9	1/4 - 28 UNF	4	13	7	21	
	106 - 111	12	M 6 x 1 tap	6	13	8	20,5	21,5
	106 - 112	12	M 8 x 1 tap	6	13	8	20,5	21,5
	106 - 113	12	M 10 x 1 tap	6	13	8	21,5	21,5
	106 - 114	12	R 1/8 BSP tap	6	13	7,5	20,5	21,5
	106 - 114 - NPT	13	1/8 NPT	6	13	8,5	21,5	
	106 - 115 - UNF	13	1/4 - 28 UNF	6	13	7	21	

Material: plated brass

pression de service 60 bar

Adapter 45°

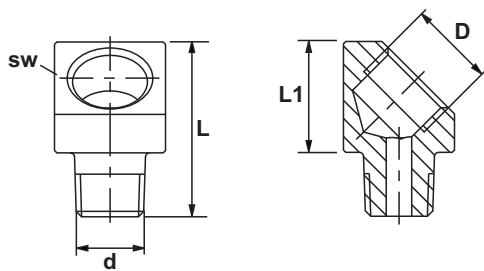

c.-item no	item no.	D	d	sw	L	L1
	100 - 822	M 8 x 1	M 8 x 1 tap	13	23	13
	100 - 823	M 8 x 1	M 10 x 1 tap	13	23	13
	100 - 833	M 10 x 1	M 10 x 1 tap	13	23	13
	100 - 844	Rp 1/8 BSP	R 1/8 BSP tap	13	23	13
	100 - 855	Rp 1/4 BSP	R 1/4 BSP tap	17	33	18

Material: steel, galvanized surface

Adapter 90°

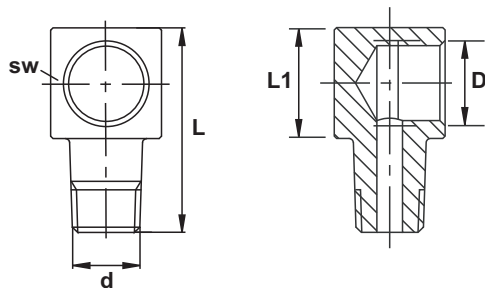

c.-item no	item no.	D	d	sw	L	L1
	100 - 711	M 6 x 1	M 6 x 1 tap	12	23	13
	100 - 721	M 8 x 1	M 6 x 1 tap	12	23	13
	100 - 722	M 8 x 1	M 8 x 1 tap	12	23	13
	100 - 723	M 8 x 1	M 10 x 1 tap	12	23	13
	100 - 733	M 10 x 1	M 10 x 1 tap	13	23	13
	100 - 744	Rp 1/8 - BSP	R 1/8 - BSP tap	13	23	13
	100 - 724	M 8 x 1	R 1/8 - BSP tap	12	23	13
	100 - 755	Rp 1/4 BSP	R 1/4 - BSP tap	17	33	18

Material: steel, galvanized surface

Adapter, extension piece

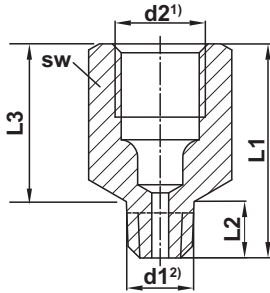

- 1) Adapter with cut for pipe union without soldering
 2) Spigot screw thread of DIN 158 keg short, res. of DIN 2999



c.-item no	item no.	Abb.	d1	d2	L1	L2	L3	sw	tube Ø
	100 - 120	1	M 6 x 1 tap	M 8 x 1	18	8	10	11	4
	100 - 130	1	M 8 x 1 tap	M 8 x 1	18	8	10	11	4
	100 - 132	1	M 8 x 1 tap	M 8 x 1	32	22	10	11	4
	100 - 135	1	M 8 x 1 tap	M 8 x 1	62,5	52,5	10	11	4
	100 - 137	2	M 8 x 1 tap	M 10 x 1	23	12	11	13	6
	100 - 140	1	M 10 x 1 tap	M 8 x 1	18	8	10	11	4
	100 - 142	2	M 10 x 1 tap	M 10 x 1	18	7	11	13	6
	100 - 141	2	M 10 x 1 tap	M 10 x 1	23	12	11	13	6
	100 - 145	2	M 10 x 1 tap	M 10 x 1	35	24	11	13	6
	100 - 143	2	M 10 x 1 tap	M 10 x 1	40	29	11	13	6
	100 - 146	2	M 10 x 1 tap	M 10 x 1	50	39	11	13	6
	100 - 151	2	R 1/8 BSP tap	M 10 x 1	18	7	11	13	6
	100 - 152	-	R 1/8 BSP tap	Rp 1/8 BSP	18	7	11	13	-
	100 - 155	2	R 1/8 BSP tap	M 8 x 1	18	7	11	13	4
	100 - 148	-	R 1/8 BSP tap	Rp 1/8 BSP	23	12	11	13	-
	100 - 149	-	R 1/8 BSP tap	Rp 1/8 BSP	35	23	12	13	-
	100 - 153	-	R 1/8 BSP tap	Rp 1/8 BSP	50	38	12	13	-
	100 - 144	2	R 1/4 BSP tap	M 10 x 1	20	9	11	17	6
	100 - 147	-	R 1/4 BSP tap	Rp 1/8 BSP	20	9	11	17	-
	100 - 162	-	R 1/8 BSP tap	Rp 1/4 BSP	22	8	14	17	-
	100 - 160	-	R 1/4 BSP tap	Rp 3/8 BSP	27	11	16	22	-

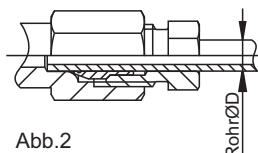
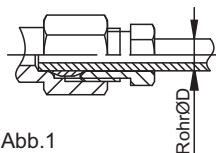

It's also possible to connect a lubrication line directly to an extension.

Material: steel, galvanized surface

Socket union for double cone olive

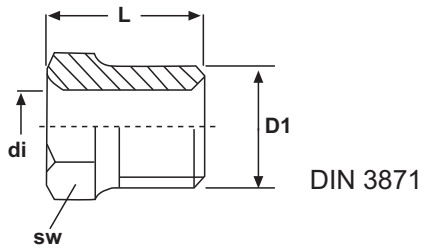

c.-item no	item no.	D1	di	sw	L
	104 - 205	M 8 x 1	4	8	12
	106 - 205	M 10 x 1	6	10	14

Material: steel, galvanized surface

Double cone olive

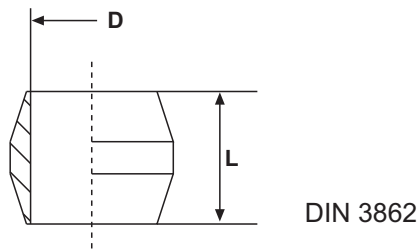

c.-item no	item no.	D	L
	104 - 215	4	5,5
	106 - 215	6	7

Material: brass

Plastic tube semi-rigid PA 12 HL

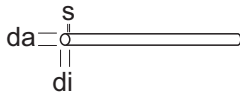

DIN 73378 + Cetop



c.-item no	item no.	item	da	s	di	lengthens
	100 - 009 - 25	6 x 1,5 *	6	1,5	3,0	25
	100 - 004	6 x 1,5 **	6	1,5	3,0	100
	100 - 003	6 x 1,5 empty	6	1,5	3,0	100
	100 - 003 - 25	6 x 1,5 empty	6	1,5	3,0	25

Pressure: ca. 1291 PSI, 9 MPA operating pressure

* With grease NLGI quality grade 2 filled

** With low viscosity grease NLGI quality grade 000 filled

Plastic tube flexibel PA 12 PHL

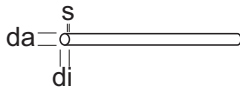

DIN 73378 + Cetop



c.-item no	item no.	color	item	da	s	di	lengthens
	100 - 005	black	4 x 0,85 *	4	0,85	2,3	50
	100 - 006	black	4 x 0,85 empty	4	0,85	2,3	50
	100 - 006 - T	tranz- parent	4 x 0,85 empty	4	0,85	2,3	50

Pressure: ca. 580 PSI, 4 MPA operating pressure

* With low viscosity grease NLGI quality grade 000 filled

High pressure hose 600-840 bar

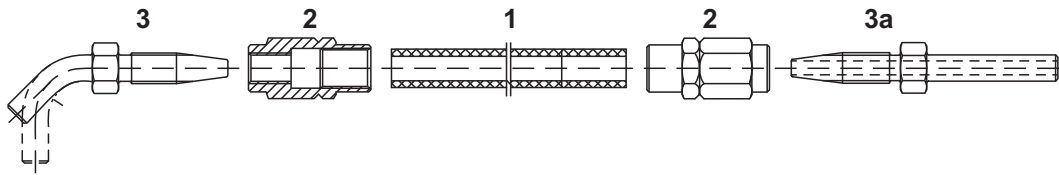

- 1 High pressure hose
- 2 Screw sleeve
- 3 Hose stud 90° or 45°
- 3a Hose stud straight

High pressure hose 600-840 bar

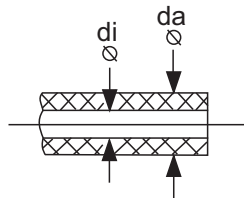

Technical information

di	da	item no.	packing unit	miscellaneous
4,0	8,6	100-001	50m coil*	with Fett Kl. 2 filled, NLGI 2
4,0	8,6	100-002	50m coil*	empty
6,3	11,3	100-011	100m coil*	with Fett Kl. 2 filled, NLGI 2
6,3	11,3	100-012	100m coil*	empty

	100-001 / 100-002		100-011 / 100-012	
	inner tube	casing	inner tube	casing
material	Termopl. Polyamid 6	Termopl. Polyurethan mikrobeinstabilisiert	Termopl. Polyamid 12	Termopl. Polyurethan, mikrobeinstabilisiert
tear strength	DIN EN ISO 527 > 30N/mm ²	> 18N/mm ²	> 38N/mm ²	> 20N/mm ²
elongation at break	DIN EN ISO 527 > 50%	> 380%	> 250%	> 320%
hardness shore	DIN EN ISO 868 D 60 ± 3	A 88 ± 3	D 61 ± 3	A 92 ± 3
temperatur using limit	-30°C till 80°C If medium to be pumped "grease with corrosion protection additives": max. 60°C			
cracking pressure	DIN EN ISO 1402 20°C >800bar, 84 MPa, 12184 psi, 60°C >450 bar Permissible bending radius for 20°C >20 mm			

Sizes and tolerances

nominal size	4,0 x 8,6 mm d	6,3 x 11,3 mm
inner diameter	3,90 - 4,10 mm	6,2 - 6,5 mm
external diameter	8,50 x 8,75 mm	11,1 - 11,5 mm
wall thickness eccentricity	max. 0,40 mm	max. 0,35 mm

Colour

inner tube	natural	glue	green-transparent
casing	black	print	white
cable armour	white		

*For delivery 5% short lengths are allowed.

Hose stud straight with and without claw groove

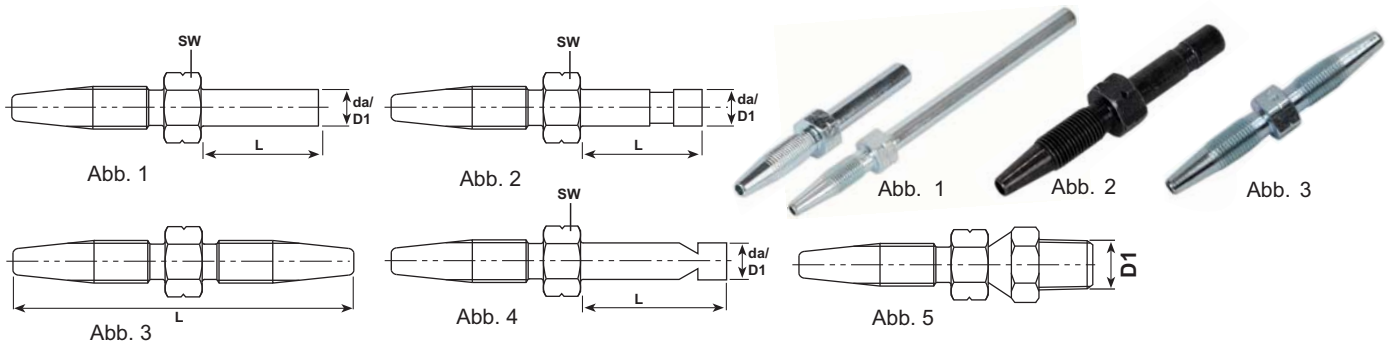

c.-item no	item no.	Abb.	da/D1	L	sw
------------	----------	------	-------	---	----

For assembling high pressure hose \varnothing 4,1 x 8,75

	100 - 054 - 4	1	4	20	10
	100 - 054	1	6	20	10
	100 - 055	1	6	24	10
	100 - 051	1	6	30	10
	100 - 091	1	6	65,5	10
	100 - 051 - 8	1	8	30	10
	100 - 054 - NUT	2	6	20	10
	100 - 051 - NUT	2	6	30	10
	100 - 055 - NUT - V	4	6	24	10
	100 - 054 - NUT - SW black	2	6	21,5	10
	100 - 051 - VA *	1	6	30	10
	100 - 061 connector	3	6	21,5	10
	100 - 051 - 1	5	1/8 npt	25	7/16"

High pressure hose \varnothing 6,35 x 11,3

	100 - 064	1	6	20	12
	100 - 064 - NUT	2	6	20	12
	100 - 064 - VA *	1	6	20	12
	100 - 074	1	8	20	12
	100 - 074 - VA *	1	8	20	12
	100 - 081	1	10	30	12

Material: steel, galvanized surface

*Material: stainless steel 1.4571/316ti

Hose stud with and without claw groove 90°

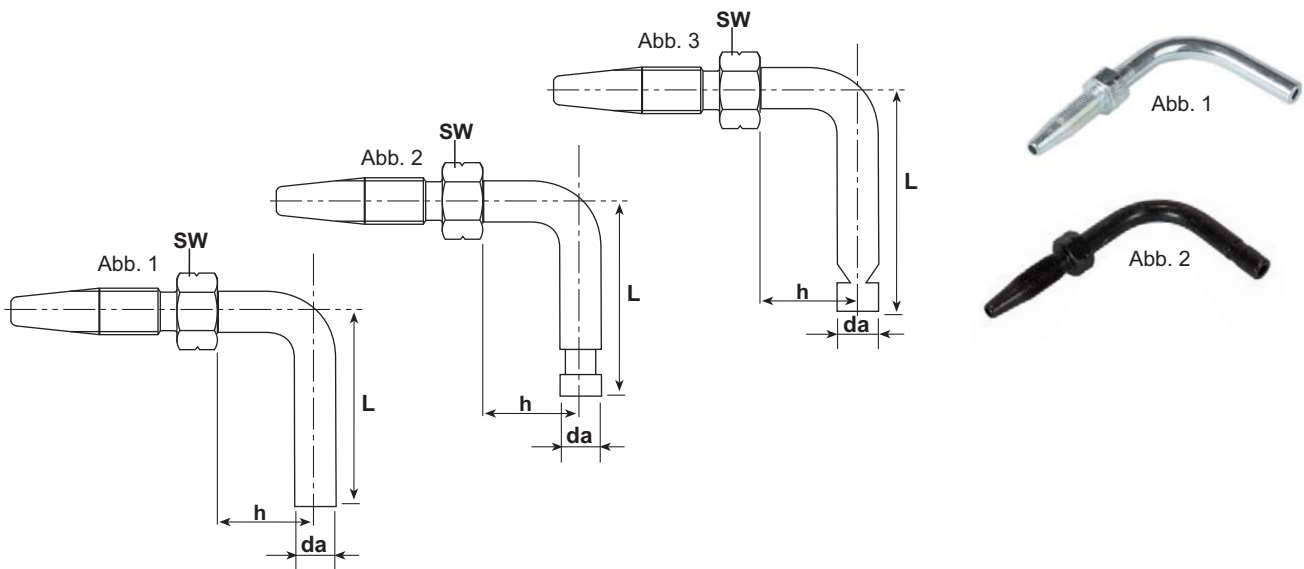

c.-item no	item no.	Abb.	da	h	L	sw
------------	----------	------	----	---	---	----

High pressure hose \varnothing 4,1 x 8,75

	100 - 059 - 4	1	4	14	30	10
	100 - 052	1	6	13	21	10
	100 - 059	1	6	14	33	10
	100 - 059 - NUT - V	3	6	14	33	10
	100 - 062	1	6	17	29	10
	100 - 053	1	6	28	37	10
	100 - 053 - VA *	1	6	28	37	10
	100 - 053 - NUT	2	6	28	37	10
	100 - 053 - NUT - SW black	2	6	28	37	10
	100 - 056	1	6	28	53	10
	100 - 056 - NUT	2	6	28	53	10
	100 - 056 - NUT - SW black	2	6	28	53	10

High pressure hose \varnothing 6,35 x 11,3

	100 - 063	1	6	22	45	12
	100 - 073	1	8	23	36	12
	100 - 073 - VA *	1	8	23	36	12
	100 - 083	1	10	23	36	12

Material: steel, galvanized surface

*Material: stainless steel 1.4571/316ti

Hose stud with and without claw groove 45°

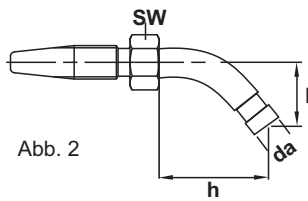
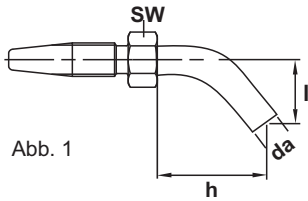

c.-item no	item no.	Abb.	da	h	l	sw
------------	----------	------	----	---	---	----

High pressure hose $\varnothing 4,1 \times 8,75$

	100 - 057	1	6	24	15	10
	100 - 057 - NUT	2	6	24	15	10
	100 - 058	1	6	35	25	10
	100 - 058 - NUT	2	6	35	25	10
	100 - 058 - NUT - SW black	2	6	35	25	10

Material: steel, galvanized surface

Screw sleeve

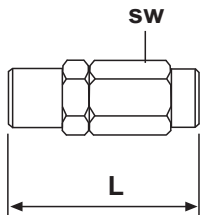

c.-item no	item no.	L	sw
------------	----------	---	----

High pressure hose Ø 4,1 x 8,75

	100 - 050	28	12
	100 - 050 - SW black	28	12
	100 - 050 - VA *	28	12

High pressure hose Ø 6,35 x 11,3

	100 - 060	35,8	17
	100 - 060 - VA *	35,8	17

Material: steel, galvanized surface

*Material: stainless steel 1.4571/316ti

Screw sleeve with hose stud 1/8 NPT

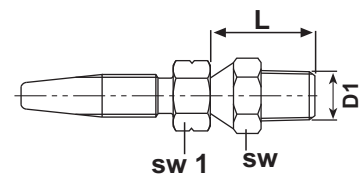
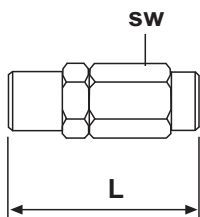

c.-item no	item no.	L	sw	sw1	D1
------------	----------	---	----	-----	----

High pressure hose Ø 4,1 x 8,75

	100 - 050 - 1 screw sleeve	26	1/2		
	100 - 051 - 1 hose stud	25	1/2	7/16	1/8 NPT

Material: steel galvanised, black chromated

Protective hose

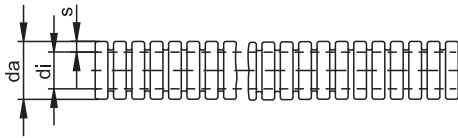

c.-item no	item no.	di	da	s	coil
	100 - 030	10	12,9	1,5	50
	100 - 031	12	15,7	1,7	50
	100 - 032	8,4	11,7	1,6	50

Material: Poliamide - PA6

Plastic helix

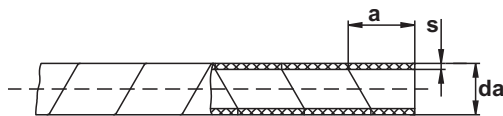

c.-item no	item no.	a	da	s	length
	100 - 040	10	6	1	25
	100 - 041	10	11,5	1,5	25

Material: PE

Elbows with tapered thread

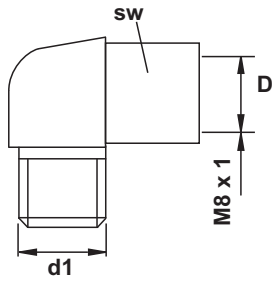

c.-item no	item no.	D	d1	sw
	104 - 121	4	M 6 x 1 tap	11
	104 - 122	4	M 8 x 1 tap	11
	104 - 123	4	M 10 x 1 tap	11

Material: brass

Socket unions for tapered sleeves

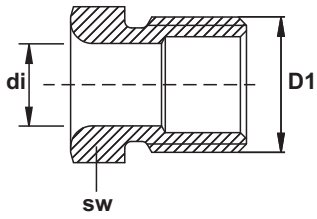

c.-item no	item no.	D1	di	sw
	104 - 220	M 8 x 1	4	8
	106 - 220	10 x 1	6	10
	110 - 220	M 16 x 1,5	10	17

Material: brass

Tapered sleeves

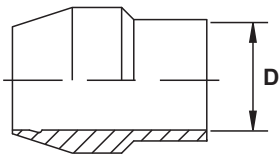

c.-item no	item no.	D
	104 - 211	4
	106 - 211	6
	110 - 211	10

Material: brass

Reinforcing socket for plastic tube



c.-item no	item no.	D	for tube Ø
	104 - 203	2,3	4 x 0,85
	106 - 203	3,5	6 x 1,25
	110 - 203	7	10 x 1,5

Material: brass

Hose strap

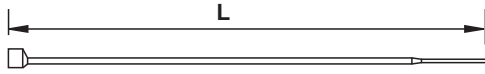

c.-item no	item no.	length x width	packaging unit
	100 - 025	200 x 5,0	100
	100 - 026	300 x 4,6	100
	100 - 027	380 x 4,7	100
	100 - 028	365 x 7,6	100
	100 - 029	780 x 9,0	100

Material: PA 6, black

Illuminated push button

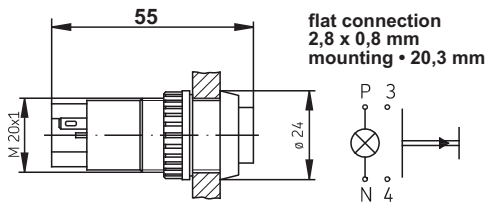

c.-item no	item no.	push button	voltage	capacity
	100 - 290	green	24 V	1,2 W
	100 - 291	green	12 V	1,2 W

Filling pump

Protection cap



Abb. 1



Bild 1

Cartridge with female thread

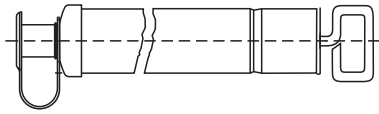

Abb. 2



Bild 2

c.-item no	item no.	Bild	Abb.	connection
	100 - 201	1	1	with stub
	100 - 204	2	2	M 26 x 1,5

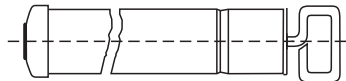
Din 1284 400 cm³ cartridge
Material: steel, chromed surface

Filling connection

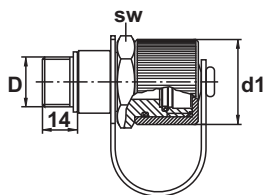

Filling connections for our filling pump, part no. 100 - 201

c.-item no	item no.	D	d1	sw
	100 - 200	M 20 x 1,5	34	32
	100 - 208	M 22 x 1,5	34	32

Material: steel, galvanized surface

Filling connection straight

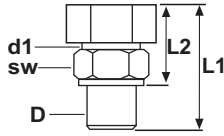

Filling connections for our filling pump, part no. 100 - 204

c.-item no	item no.	L1	L2	D	d1	sw
	100 - 202	38	26	M 22 x 1,5	M 26 x 1,5	27
	100 - 202 - 1	55	43	M 22 x 1,5	M 26 x 1,5	27
	100 - 202 - 2	75	63	M 22 x 1,5	M 26 x 1,5	27

Material: steel, galvanized surface

Filling connection 90°

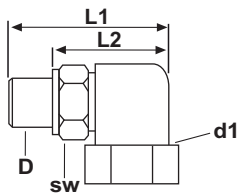

Filling connections for our filling pump, part no. 100 - 204

c.-item no	item no.	L1	L2	D	d1	sw
	100 - 203	71	58	M 22 x 1,5	M 26 x 1,5	27
	100 - 203 - 1	93	81	M 22 x 1,5	M 26 x 1,5	27
	100 - 203 - 2	112	100	M 22 x 1,5	M 26 x 1,5	27

Material: steel, galvanized surface

Filling connection straight

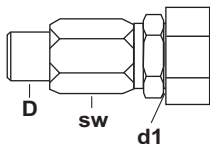

Filling connection for our filling pump, part no. 100 - 204

c.-item no	item no.	D	d1	sw
	100 - 207	M 20 x 1,5	M 26 x 1,5	27

Material: steel, galvanized surface

Coupling female

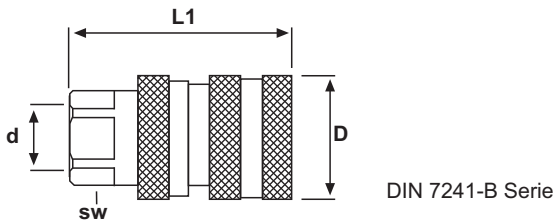

c.-item no	item no.	d	L1	D	sw	operating pressure
	100 - 205 - 1/4	Rp 1/4 BSP	57	28	19	340 Bar
	100 - 205 - 3/8	Rp 3/8 BSP	64	36	23	270 Bar

Material: steel, galvanized surface

Coupling male

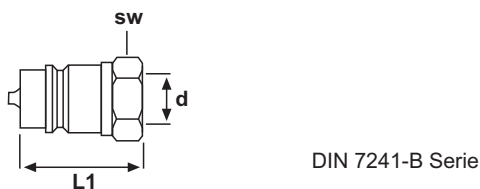

c.-item no	item no.	d	L1	sw	operating pressure
	100 - 206 - 1/4	Rp 1/4 BSP	36	19	340 Bar
	100 - 206 - 3/8	Rp 3/8 BSP	43	21	270 Bar

Material: steel, galvanized surface

Adapter

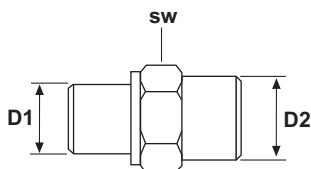

c.-item no	item no.	D1	D2	SW
	100 - 209	R 1/4 BSPP	R 1/4 BSPP	17
	100 - 209 - 20 x 1,5	R 1/4 BSPP	M 20 x 1,5	24
	100 - 209 - 22 x 1,5	R 1/4 BSPP	M 22 x 1,5	24

Material: steel, galvanized surface

Coupling female screw

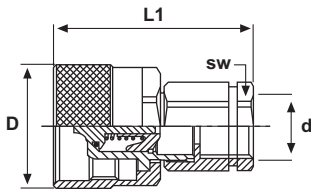

DIN 7241-B Serie



c.-item no	item no.	d	L1	D	sw	operationg pressure
	100 - 234	Rp 1/4 BSP	60	34	19	450 Bar

Material: steel, galvanized surface

Coupling male screw

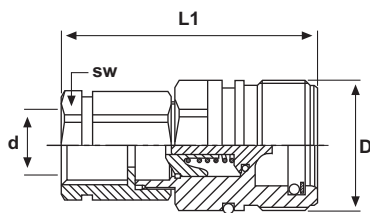

c.-item no	item no.	d	L1	D	sw	operationg pressure
	100 - 224	Rp 1/4 BSP	59,30	Rd 24 x 2	19	450 Bar

Material: steel, galvanized surface

Coupling socket with return flow port

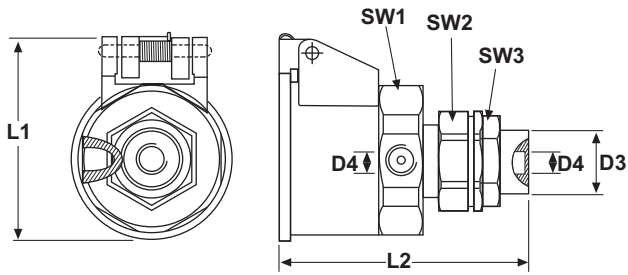

c.-item no	item no.	L1	L2	SW1	SW2	SW3	D3	D4
	100 - 226	68	84	46	30	27	M 20 x 1,5	M 10 x 1

Material: plastic, brass, steel

Coupling plug

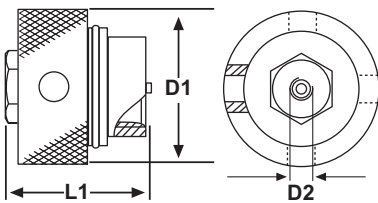

c.-item no	item no.	L1	D1	D2
	100 - 225	52	55	M 10 x 1

Material: brass, steel

Stub for coupling plug

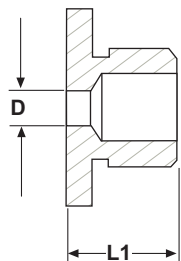
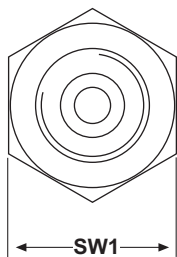

c.-item no	item no.	SW1	L1	D
	100 - 227	36	24,5	8

Material: steel, galvanized surface

Dust cover for stub

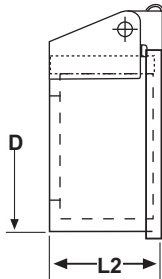
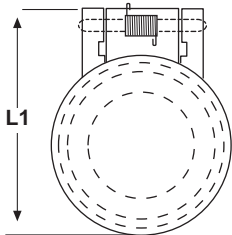

c.-item no	item no.	L1	L2	D
	100 - 228	68	33,5	50

Material: plastic

Junction block T-drilled thread M10x1

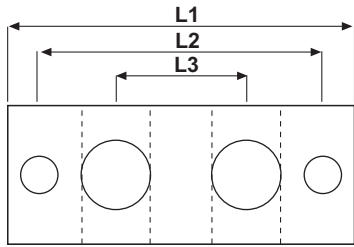

example of application



c.-item no	item no.	number of connections	L1	L2	L3
	100 - 211	1	30		
	100 - 212	2	60	50	22
	100 - 213	3	80	74	22
	100 - 214	4	106	96	22
	100 - 215	5	128	118	22
	100 - 216	6	150	140	22
	100 - 218	8	194	184	22

Material: steel, galvanized surface

Closure plug

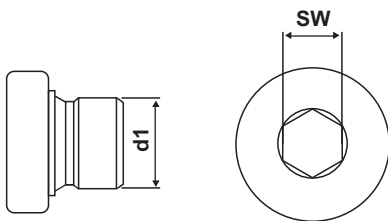

c.-item no	item no.	d1	sw
	100 - 243	M 10 x 1	5
	100 - 243 - SW black	M 10 x 1	5

Material: steel, galvanized surface

T-banjo fitting

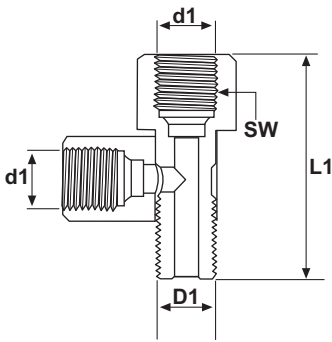

c.-item no	item no.	SW	L1	D1	d1
	100 - 323	14	35	M 10 x 1	M 10 x 1
	100 - 324	14	35	R 1/8	M 10 x 1

example of use

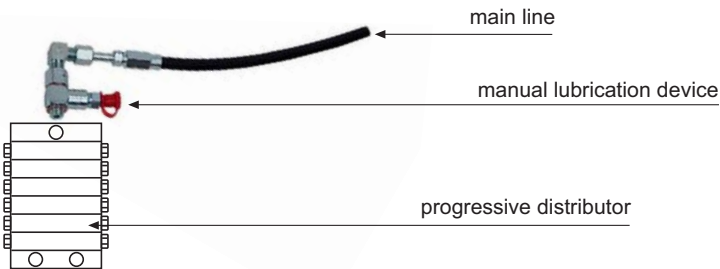

Material: 11SMnPb30 + C, galvanized surface

High pressure grease nipple

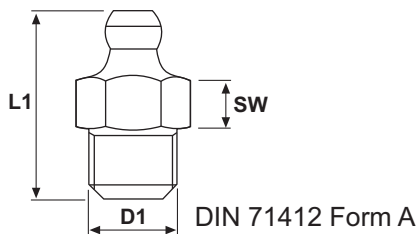

c.-item no	item no.	SW1	L1	D1
	250 - 003 - RV	11	20,7	M 10 x 1 tap
	250 - 004 - RV	11	20,7	R 1/8 PT

example of use



Material: 11SMnPb30 + C

Material: galvanized surface ISO 4042 A3F

Manometer

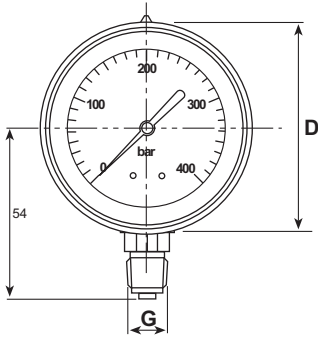

c.-item no	item no.	G	D	Max Bar	Max PSI
	100 - 255	1/4	63	400	6000

Material: Body stainless Steel, brass connection

glycerine filled

Adjustable screw connection with gasket for manometer

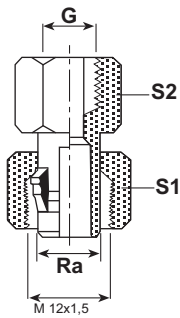

c.-item no	item no.	G	Ra	S1	S2
	106-245-L	1/4 BSP	6 L	14	19

Material: steel, galvanized surface

Rubber lined tube clamp DIN 3016

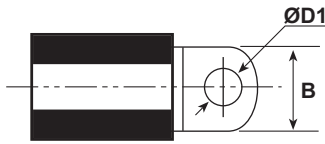
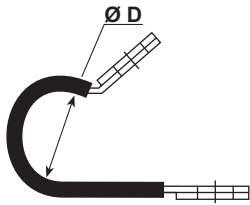

c.-item no	item no.	Ø D mm	Ø D1 mm	B mm	packaging unit
	100 - 506	6	5,3	12	100
	100 - 509	9	5,3	12	100
	100 - 512	12	5,3	12	100
	100 - 515	15	5,3	12	50
	100 - 518	18	5,3	12	50
	100 - 522	22	5,3	12	50
	100 - 525	25	5,3	12	50
	100 - 606	6	6,4	15	100
	100 - 609	9	6,4	15	100
	100 - 610	10	6,4	15	100
	100 - 612	12	6,4	15	50
	100 - 615	15	6,4	15	50
	100 - 618	18	6,4	15	50
	100 - 620	20	6,4	15	50
	100 - 622	22	6,4	15	50
	100 - 625	25	6,4	15	50

Material: steel, galvanized surface, rubber EPDM

